

Fabrication and Rapid Prototyping

Haptics Symposium Tutorial: Tools
and Techniques for Prototyping
Haptic Interfaces

March 4, 2012

William Provancher
University of Utah

Outline

- Conventional Prototyping Methods
 - Very fast overview
- CNC Laser and Waterjet Cutters
- Solid Freeform Fabrication
- Examples, Basic Haptics Prototyping Building Elements, and Tips



Conventional Prototyping

Increasing Skill Level & Cost



- Hot glue, foam core, zip ties...
- Dremel, hand drill, hand saws...
- Hot foam cutter
- Band saws, drill presses, sheet metal break, pop rivets, taps/dies...

- Manual milling machines and lathes

- Welding & Brazing

- CNC Router (for wood and plastic parts) (Light duty CNC Milling Machine)
- CNC Milling Machines
- CNC Lathes

Conventional Prototyping

- Hot glue, foam core, zip ties...



[homedepot.com]



[<http://www.modeltrainsoftware.com/mbarticle.html>]

Conventional Prototyping

- Dremel, hand drill, hand saws...



[craftsman.com]



[greatnecktools.com]



[http://www.popularmechanics.com]



[http://www.lowes.com]

Conventional Prototyping

- Hot foam cutter



~\$160

<http://www.micromark.com/>

Conventional Prototyping

- Band saws, drill presses, sheet metal brake, pop rivets, taps/dies...



Conventional Prototyping

- Manual milling machines and lathes

\$3-25k

\$2-20k



<http://www.northerntool.com>

<http://metalworkingtool.net>



Conventional Prototyping

- **Welding & Brazing (and spot welding)**



Gas metal arc welding

<http://en.wikipedia.org/wiki/Welding>



Spot welder



TIG Welding

[<http://www.weldingengineer.com>]

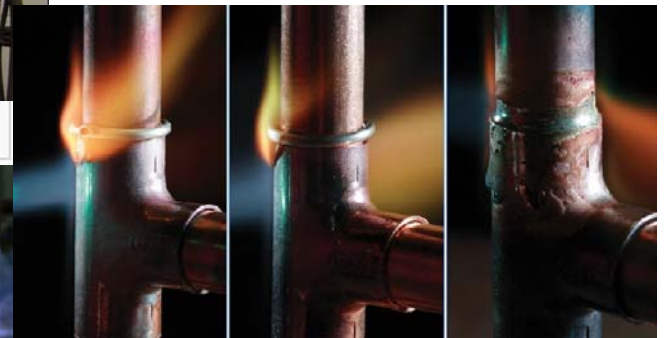

Brazing

<http://www.eutecticusa.com>

Conventional Prototyping

- CNC Router/Engraver (for wood and plastic parts) (Light duty CNC Milling Machine)
- CNC Milling Machines
- CNC Lathes



<http://www.engravingmachinesite.com/category/cnc-engraving/>



TM-1P
Starting at \$33,995.00



TL-1
Starting at \$25,995.00



MINIMILL
Starting at \$31,995.00

<http://www.haascnc.com>

CNC Laser and WaterJet Cutters

- Laser cutters
 - More common
 - Cuts plastics and wood well
 - **Issues with venting fumes** (can't just put in corner of your lab)!!
- WaterJet Cutters
 - Usually more expensive
 - Needs 3-phase power + water + space that is tolerant of sprayed water + loud
 - Can cut metal, plastic, some composites if careful

Example Laser Cut Parts

- Rather than acrylic, consider polycarbonate for better toughness



Univ. of Michigan,
Brent Gillespie



Rice Haptic Paddle,
Marcia O'Malley

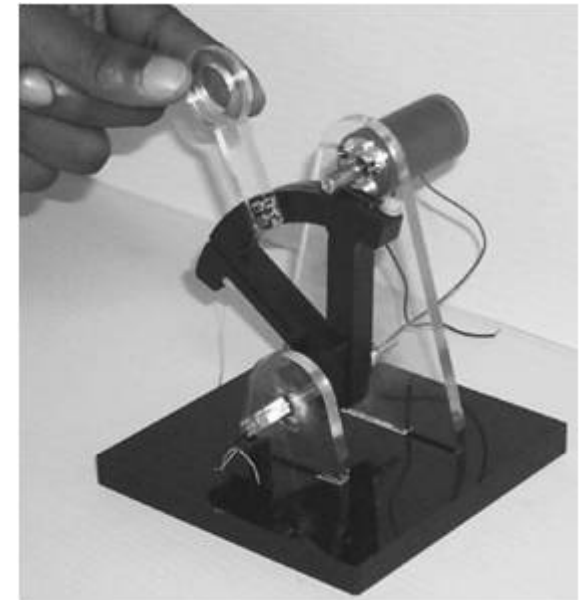

Stanford Haptic Paddle,
Mark Cutkosky

Example Laser Cut Parts



Univ. of Michigan, Brent Gillespie
medicalxpress.com

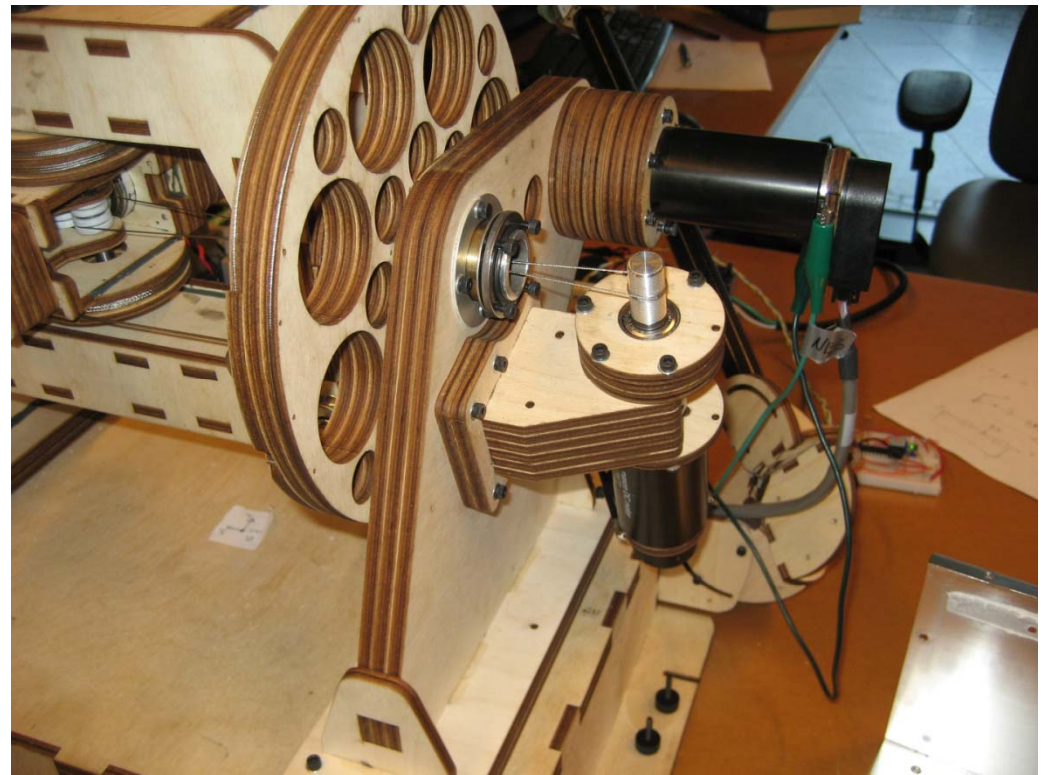

Stanford Robotics Laboratory,
Ken Salisbury

Examples of WaterJet cut parts

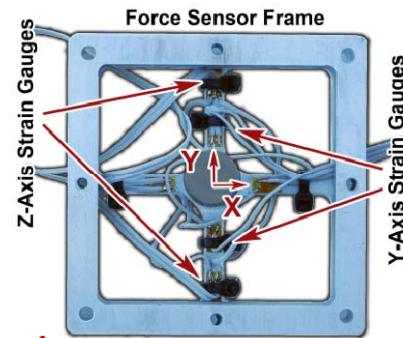

Aluminum force sensor

Aluminum handle with integrated force sensor

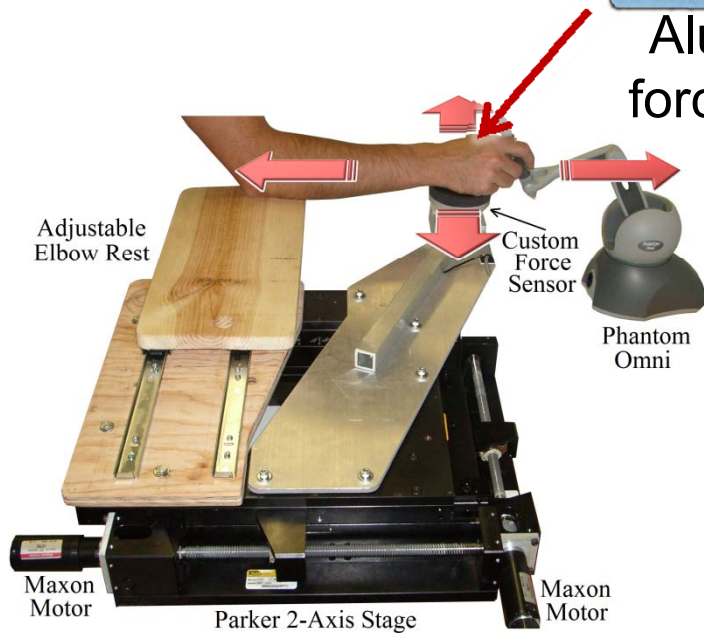
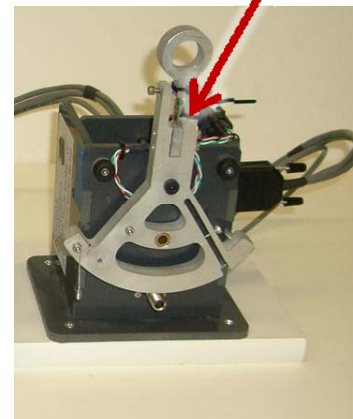

Active Handrest's extension plate and force sensor

Utah Haptic Paddle

PVC base, aluminum handle with integrated force sensor (M. Rasmussen, M. Fehlberg, A. Doxon, W. Provancher)

CNC Laser cutters



Open Gantry
With fume suction through table



Beam Dynamics LMC500



Enclosed
Fumes evacuated through ducts

Laser cutter pricing/info

Name	Workspace	Accuracy / Resolution	price	Materials / capabilities
Universal Laser Systems (ULS) VersaLaser VL-200	12 x 16 inches <i>(12 x 24" for VL-300 and add ~\$2k to prices)</i>	?? 	\$7.7K (10 watt) \$11K (30 watt) (as of 2006)	- Thin Acrylic - Cardboard <i>(VL-300 is more recommended)</i>
Beam Dynamics LMC2000 (100 W laser)	48 x 48 Inches	??	\$110K + S/H -\$10K ac. disc.	- 1" thk. plastic - 1" thk. wood - 0.06" steel
Kern Elec. & Laser HSE 52 series (100 W laser)	52 x 50 inches	±0.002"	\$87K + S/H -\$14K ac. disc.	- 1" thk. plastic - 1" thk. wood - 0.06" steel
Kern Elec. & Laser HSE 52 series (150 W laser)	52 x 50 inches	±0.002"	\$107K + S/H -\$12K ac. disc.	- 1" thk. plastic - 1" thk. wood - 0.1" steel

(Abrasive) Water Jet Cutter (e.g., OMAX 2626)

- Cuts a wide variety of materials (H₂O + garnet)
 - Aluminum, Steel
 - Wood, Plastic
 - Difficult to cut composites cleanly
- Small taper at top of part (can use slower min. taper setting)
- \$35/hr actual operating cost + maintenance
- Consumes garnet and nozzle “jewel” and hard on other high pressure components



[<http://www.omas.com>]

Example parts cut on OMAX waterjet

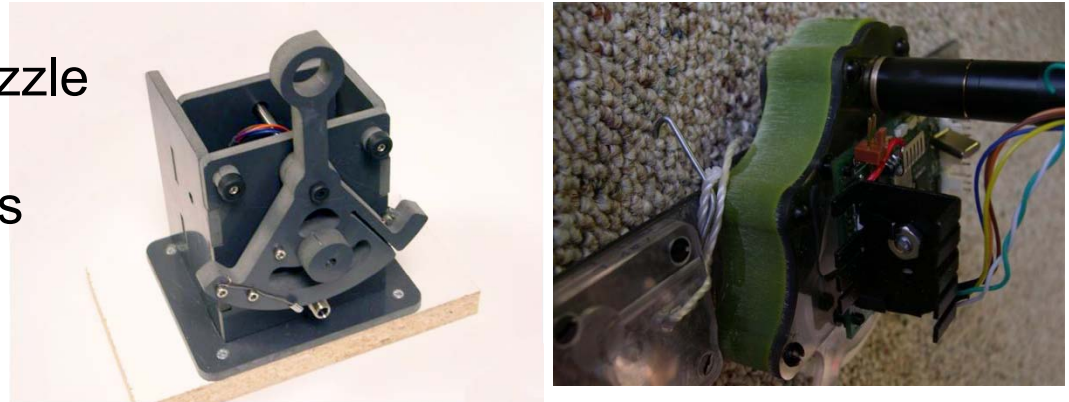

WaterJet Cutter Pricing/Info

Name	Workspace	Accuracy / Resolution	price	Materials / capabilities
OMAX 2626 WaterJet Cutter	29 x 26 inches (737 mm x 660 mm)	±0.003 inches (±0.08 mm).	\$99k + s/h + garnet + \$8K for solids removal system Actual operating cost ~\$35/hr + maintenance	plastic aluminum Steel Some composites Not great for wood products Need 3-phase power + water + space that is water tolerant + loud

Pricing goes up from there...

Tips/Info for laser cut parts

- Laser cutter
 - Acrylic is most common build material → use polycarbonate for improved toughness
 - Wood is popular for high stiffness, low mass designs (e.g., laminated Baltic birch plywood)
 - Medium Density Fiberboard (MDF) is another cheap, but lower performance option

Guidance/tips for flat-stock cut parts

- Use finger joints with “tendons” 2x or more in length than material thickness if possible
 - Design joints with zero clearance, kerf of cut will usually create clearance
- If you use a tough material, like PVC, you can self tap threaded holes (saves time)

←
(width)

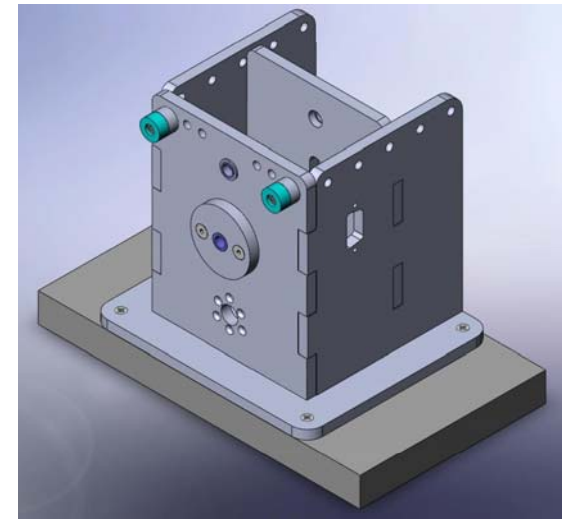
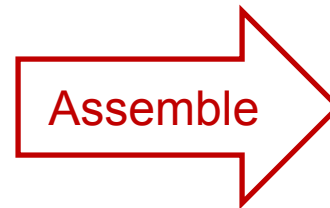
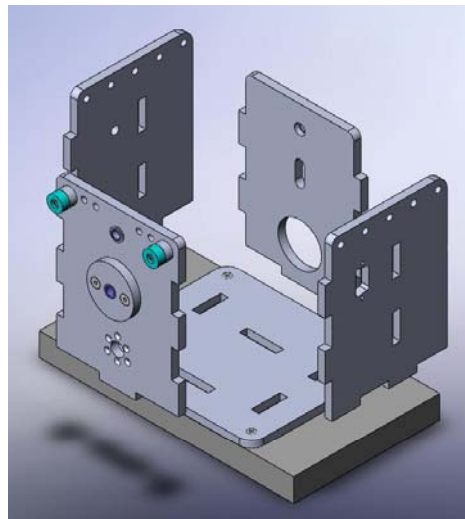

See Utah Haptic Paddle assembly instructions on Eduhaptics.org

Free-Form Fabrication

- Free-form fabrication can be thought of as “**3-D printers**” that create three-dimensional objects from computer files.
- Most of the technologies construct an object, one cross-sectional layer at a time, by depositing a material or by selectively solidifying a liquid.
 - **Build material: plastics, wax, paper, ceramics, metals and foam.**

Source: Ulrich K, Eppinger S, *Product Design and Development*

Free-Form Fabrication

Rapid Prototyping

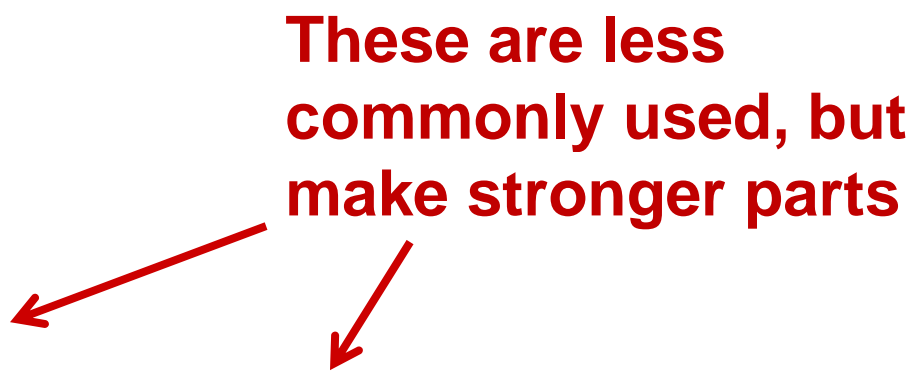
- Stereolithography (SLA)
 - Fused Deposition Modeling (FDM)
 - 3D Printing (3DP)
 - Objet
 - Projet
 - Investment casting
 - Selective Laser Sintering (SLS)
 - *Not really free-form fabrication, but can use its prototypes*
- These are less commonly used, but make stronger parts**
- 

STL File

- The STL file slices a volume into layers of constant thickness.

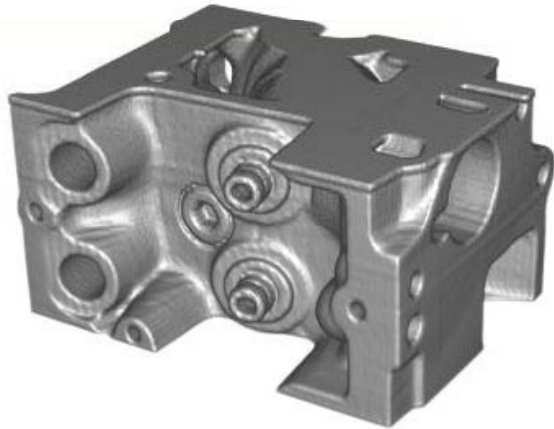

Solid model

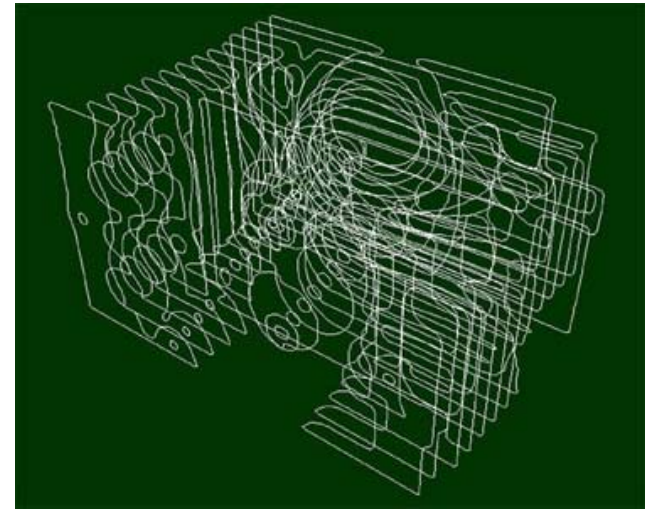
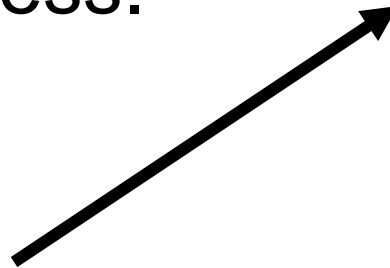

STL model

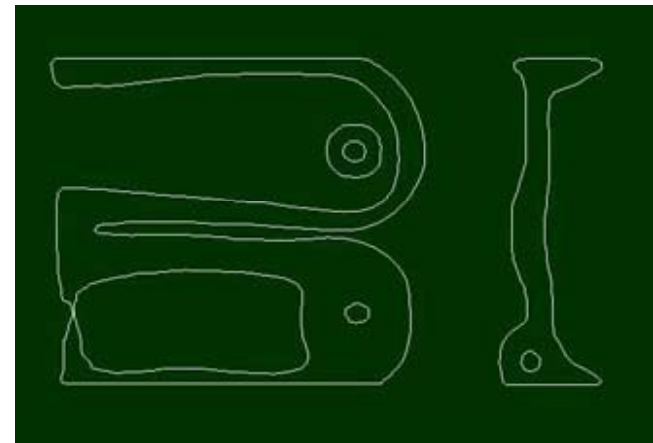

STL single slice

Stereolithography (SLA)



Layered
Part geometry
(stl file)

Support
Structure

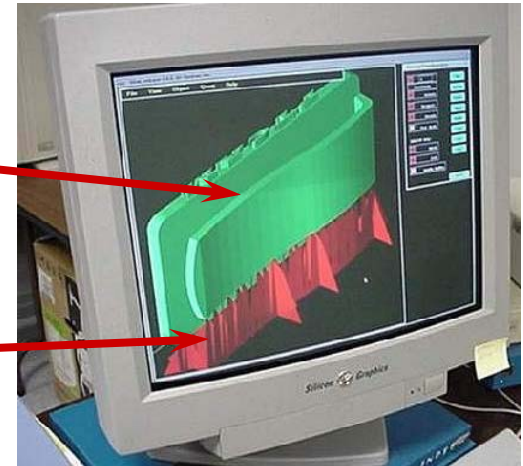

The platform in the tank of photopolymer

Source: howstuffworks.com

Stereolithography (SLA)

- Stereolithography
 - CAD designs into solid objects through a combination of laser, photochemistry and software technologies.
- A laser beam of ultraviolet light is then focused onto the surface of a vat of liquid photopolymer.
-  The laser traces a cross section of the part, turning a thin layer of the liquid plastic to solid.
- The cross-section is lowered and recoated with liquid photopolymer and the laser traces the next slice on top of the previous one.
- The process continues layer by layer until complete.

Source: 3DSYSTEMS

Stereolithography (SLA)

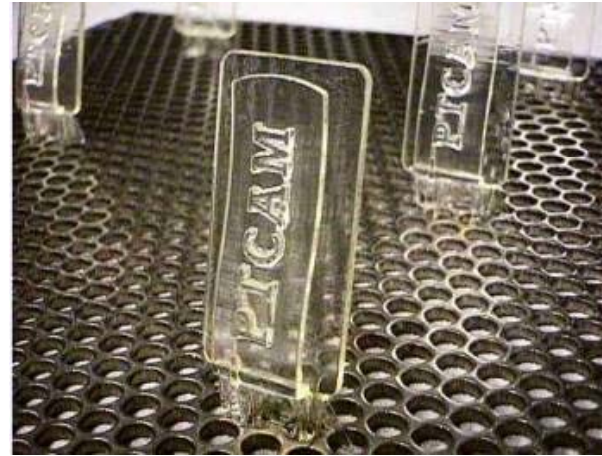

The platform with SLA parts



UV post-cure

Source: howstuffworks.com

SLA (Stereolithography) (3D Systems)

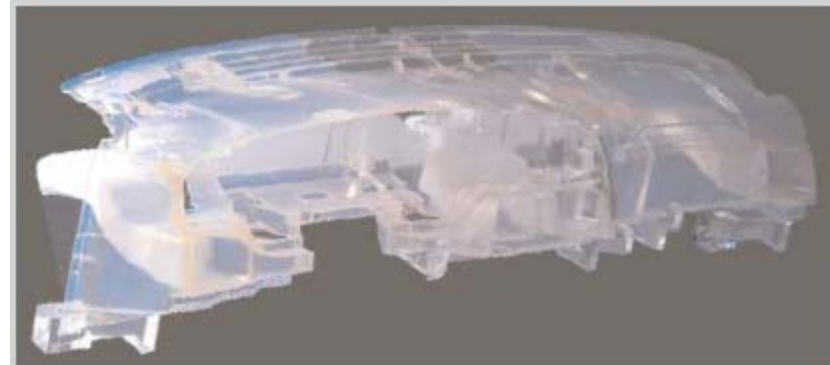

	Viper	Viper Pro
Workpiece size	250x250x250 mm	650x350x300 mm
Speed	5 mm/s	3.5 – 25 m/s
Layer thickness	N/A	0.05-0.15 mm
Materials	Accura 25 (similar to PP), Bluestone (nano-composite), Accura 50 (similar to ABS), etc...	



Printer assembly of production (blue) parts and prototypes produced with si 50 grey and natural material

Source: 3DSystems

Fused Deposition Modeling (FDM)

- **Fused deposition modeling** (FDM) works on an "additive" principle by laying down material in layers.
- A plastic filament or metal wire is unwound from a coil and supplies material to an extrusion nozzle which can turn on and off the flow.
- The nozzle is heated to melt the material and can be moved in both horizontal and vertical directions by a numerically controlled mechanism, directly controlled by a Computer Aided Design software package.
- In a similar manner to stereolithography, the model is built up from layers as the plastic hardens immediately after extrusion from the nozzle.
- Available materials include ABS, polycarbonates, polyphenylsulfones and waxes.
- A water-soluble material can be used for making temporary supports while manufacturing is in progress, which can simply be washed away after fabrication.

Source: Wikipedia.org

FDM (Stratasys and Stratasys offshoot Dimension)



Dimension SST 1200es

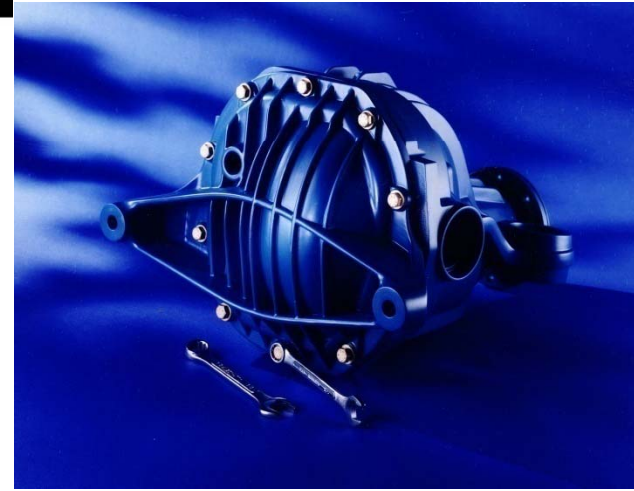

Source: Stratasys

	Dimension SST 1200es
Workpiece size	10 x 10 x 12 in.
Cost	\$32,900*
Layer thickness	0.01 in. (.25 mm)
Materials	ABS

Examples of FDM prototypes

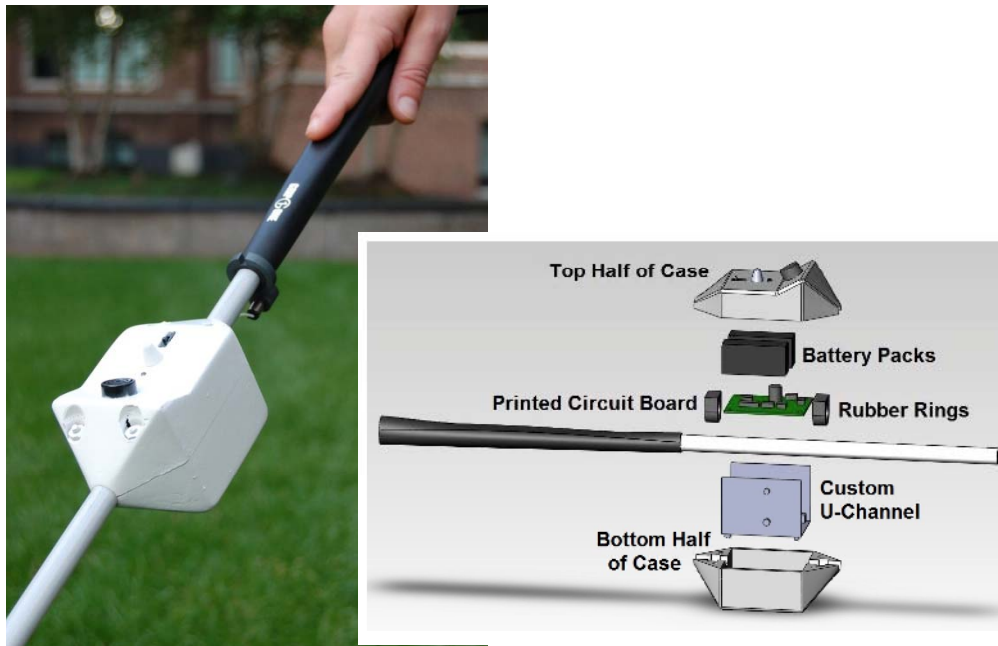

HALO: Haptic Alerts for Low-hanging Obstacles
in White Cane Navigation
Courtesy of K. Kuchenbecker

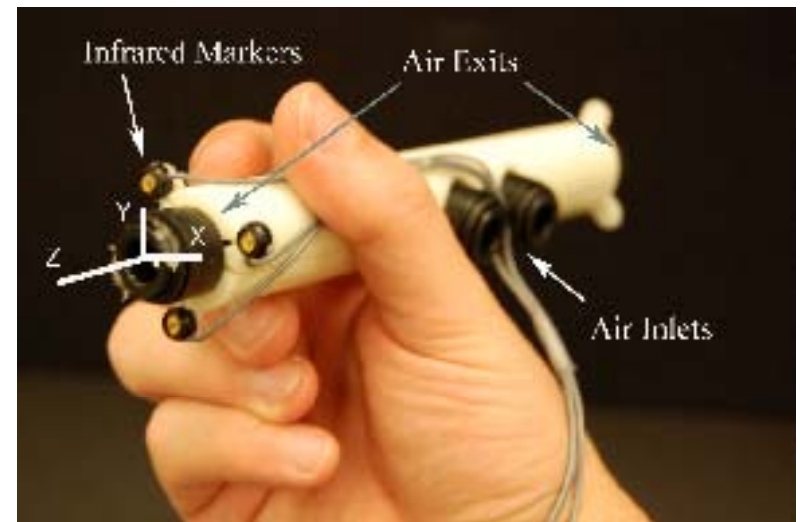

AirWand: A Large-Workspace
Force-Feedback Haptic Device
Courtesy of K. Kuchenbecker

Examples of FDM prototypes

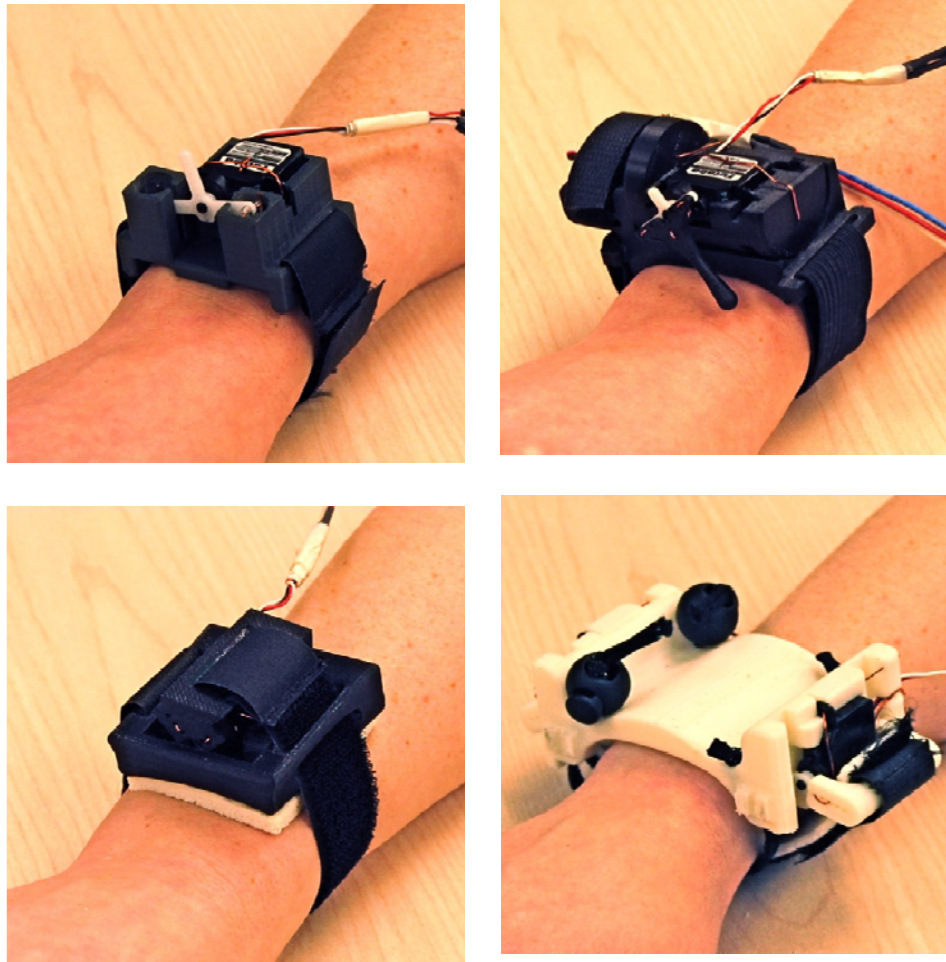

Body Grounded Tactile Actuators
Courtesy of K. Kuchenbecker

FDM & WaterJet Cut Electronics Enclosure



0-80 Inserts

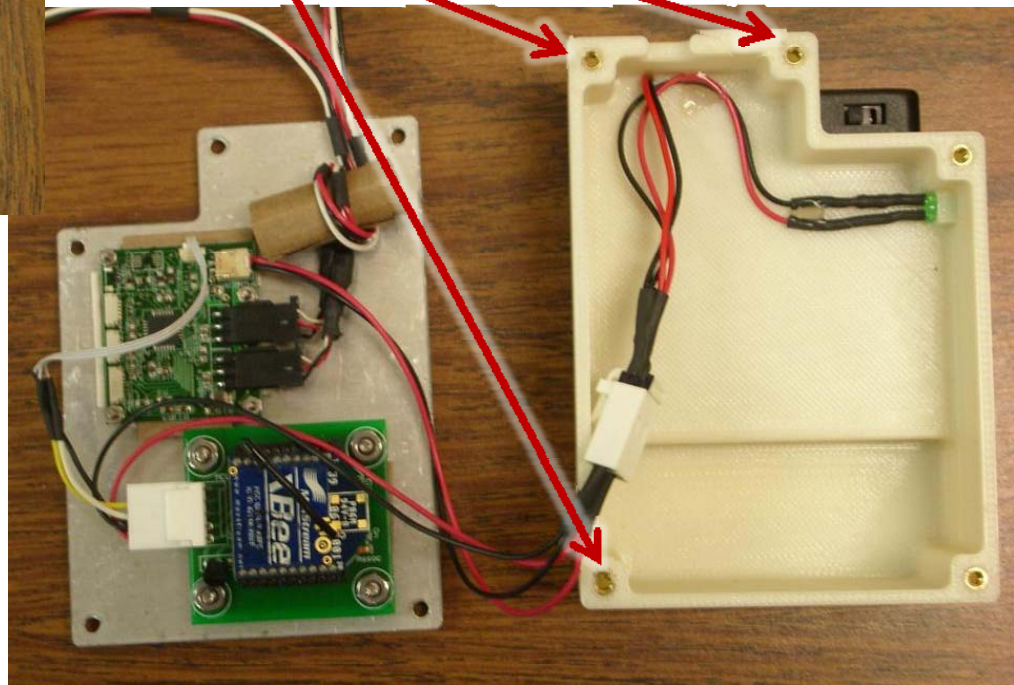

See: Medeiros-Ward, N., Cooper, J. M., Doxon, A. J., Strayer, D. L., and Provancher, W. R., "[Bypassing the Bottleneck: The Advantage of Fingertip Shear Feedback for Navigational Cues](#)," Proc. of the Annual Meeting of the Human Factors and Ergonomics Society, Sept, 2010, pp. 5.

3D Printing

- **Three dimensional printing (3DP)** is based on an adapted inkjet printing system.
- The process deposits layers of a fine powder (either cornflour or plaster) that are selectively bonded by "printing" a water-based adhesive from the inkjet printhead in the shape of each required cross-section.
- Alternately, liquids are fed into individual jetting heads which squirt tiny droplets as they are scanned to form a layer of the model. The liquid hardens after being deposited.
- Once a single layer has been deposited, a milling head may be employed to ensure uniform thickness before the next layer is deposited.
- Unlike "traditional" RP systems such as stereolithography and fused deposition modeling, 3DP is optimized primarily for speed and low-cost, making it suitable for visualizing during the conceptual stages of engineering design when dimensional accuracy and mechanical strength of prototypes are not important.

Source: Wikipedia.org

Objet Connex

- Objet Connex technology can print multiple materials in a single build (multiple stiffnesses and/or colors)



Objet 260 Connex



Transparent and opaque combinations



Assembled product simulation in a single build

Projet Connex

- ProJet has nicer surface finish and slightly better resolution than Objet (and I'm told easier maintenance)



ProJet™ HD 3000

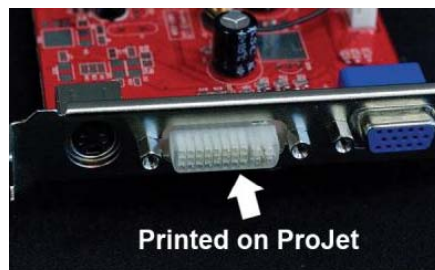

3D Printing (ZCorporation)



Choose from a variety of interchangeable materials to suit your needs, be it strength & detail, speed & economy, and anything in between!

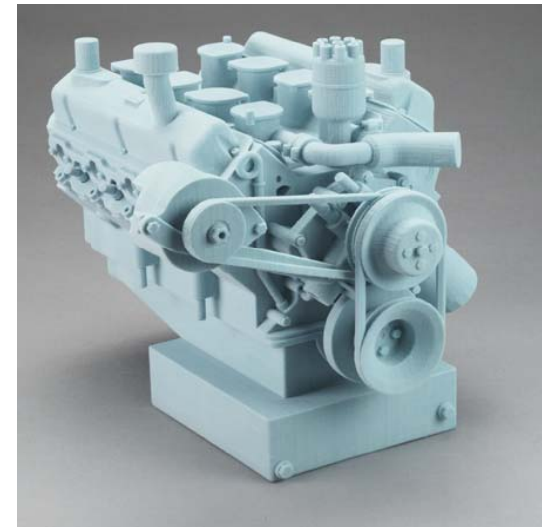

	Z310 Plus	Z810
Workpiece size	203x254x203 mm	500x600x400 mm
Speed	2-4 layers/min	N/A
Layer thickness	0.089-0.203 mm	0.089-0.203 mm
Materials	High performance composite, snap-fit, elastomeric, direct casting, investment casting	

Source: ZCorporation

3D Printer Info/Costs

Name	Workspace	Accuracy / Resolution	price	capabilities
Objet 260 Connex	10 x 10 x 8 inches (250 x 250 x 200 mm)	0.0006 in (16 μm)	\$167k + \$1.6K s/h + ~\$13K tax	Multi-material (soft+hard in same build) More difficult to maintain
Objet Alaris30	11.5 x 7.5 x 6 inches		\$40.5k + \$2k install + \$3.2K equip + \$1K starter materials	
Objet24 Desktop 3D Printer	9.2 x 7.5 x 5.8 inches	0.001.1 in (28 μm)	\$19.9K	
ProJet™ HD 3000	11.75 x 7.3 x 8 inches (298 x 185 x 203mm)	0.001-0.002 inch (0.025-0.05 mm)	\$85K + \$6K accessories - \$9K ac. disc.	- Different materials available, in separate builds

3D Printer Info/Costs

Name	Workspace	Accuracy / Resolution	price	capabilities
ProJet™ 1000 Personal 3D Printer	6.75 x 8 x 7 in (171 x 203 x 178 mm)	0.004 in (102 µm)	??	- 1 material - 1 color
Z-Printer 310 Plus (Current model is Z-Printer 350 Pro)	8 x 10 x 8 inches (203 x 254 x 203 mm) (based on ZPrinter 350 pro)	0.006 inches,(0.15 mm) Based on ZPrinter 350 pro	\$19.9K w/ ac. disc. w/ starter materials kit + \$2k equip + s/h + tax	- 1 material - 1 color
ZPrinter 450	8 x 10 x 8 inches (203 x 254 x 203 mm)	0.004 inches (0.1 mm)	\$39.9K – \$5K ac. disc. + \$2.7K for starter materials kit	- 1 material - Many colors - Faster than Z-Printer 350 Pro (2 print heads)

3D Printer Info/Costs

Name	Workspace	Accuracy / Resolution	price	capabilities
ZPrinter 450	8 x 10 x 8 inches (203 x 254 x 203 mm)	0.004 inches (0.1 mm)	\$39.9K – \$5K ac. disc. + \$2.7K for starter materials kit	- 1 material - Many colors - Faster than Z-Printer 350 Pro (2 print heads)
ZPrinter 650	10 x 15 x 8 inches (254 x 381 x 203 mm)	0.004 inches (0.1 mm)	\$39.9K – \$10K ac. disc. + \$7.5K for starter materials kit	- 1 material - Many colors - Faster than Z-Printer 450 Pro (5 print heads)
Dimension SST1200es	10 x 10 x 12 inches	0.010 in. (.25mm) layers	\$34.9k + \$3K for start materials kit + \$650 ship/install	- 1 material - Many colors - (\$3.75/ cubic inch actual material cost)

Some FDM fabrication houses

- If you need FDM parts made, but you don't have access to an FDM machine, here are a few places you could consider ordering from
 - Redeye, <http://www.redeyeondemand.com>
 - Faster, but more expensive
 - Shapeways, <http://www.shapeways.com/>
 - Less expensive, but slower turn-around time (~1-2 weeks)
 - Other places I found by doing a quick search
 - <https://www.printaproto.com>
 - http://www.centerofengineering.com/fdm_parts.html
 - <http://www.alphaprototypes.com/>
 - Also see: <http://www.alibaba.com/showroom/fdm-parts.html>

Freeform Solid Fabrication

3D Printer Summary

- Typically \$3-4K yearly maintenance contract is typical (travel cost extra)
- Dimension FDM (Fused Deposition Manufacturing) is one of more common machines and technologies
- SLA (Stereo Lithography) is one of the oldest RP technologies
- Objet Connex can do multiple material types, but is said to require more maintenance
- Project is competitive with Objet, but has slightly better surface finish, higher tolerances and easier maintenance

Investment Casting

- You can print an FDM or other 3D printed part and have it cast using Investment Casting
- Investment casting encases your part in plaster (called “investment”) to become the mold

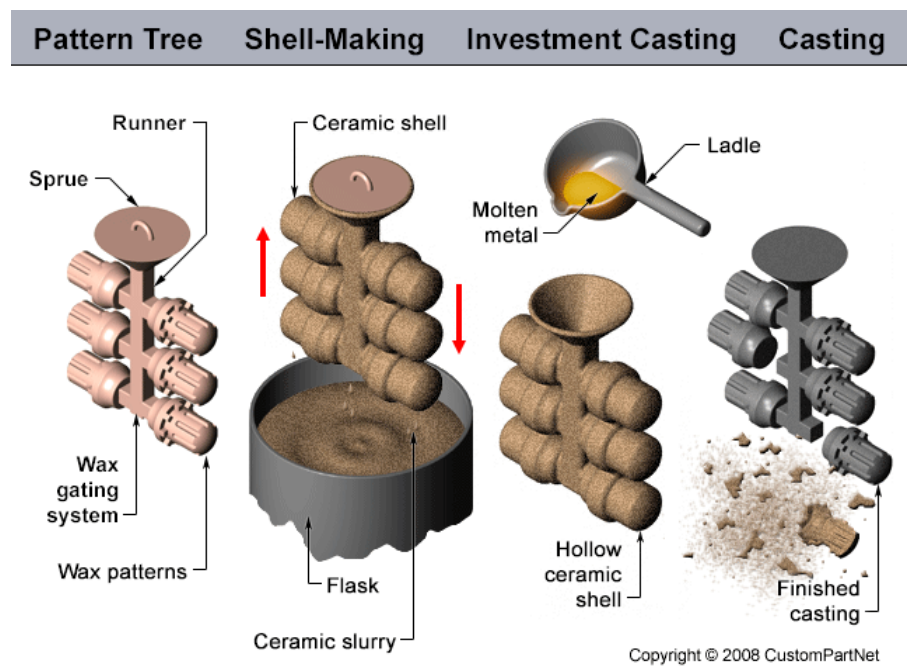

Investment Casting, cont.

- You add “sprues” fill holes that connect to your part
- Your part is “burned out” when metal is cast, similar to the lost wax / lost foam process.
- Break the plaster mold to remove part
- Common materials: Bronze, aluminum, silver...

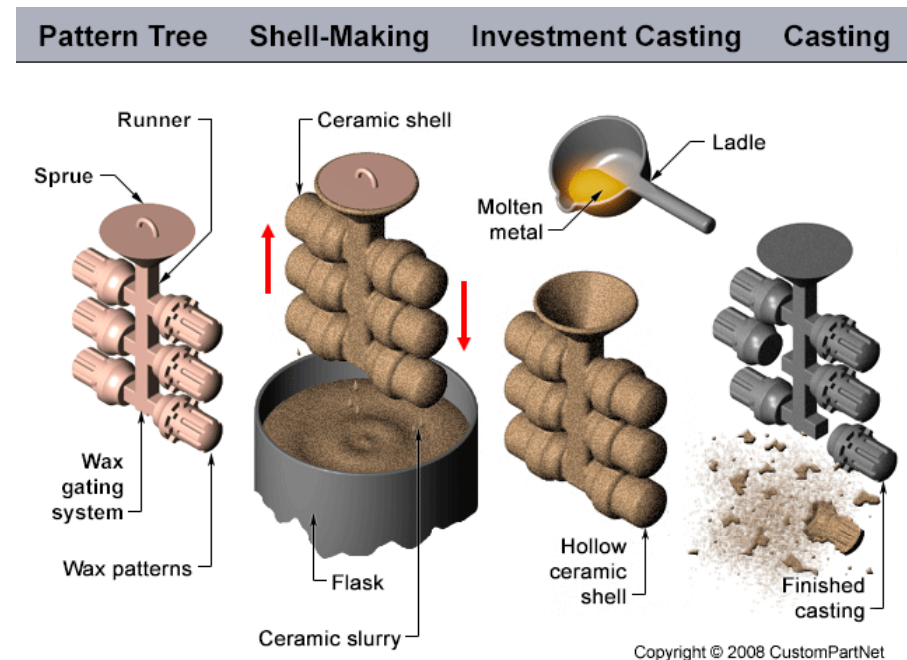

Selective Laser Sintering (SLS)

- **Selective Laser Sintering** is an additive rapid manufacturing technique that uses a high power laser to fuse small particles of plastic, metal, or ceramic powders into a mass representing a desired 3-dimensional object.
- The laser selectively fuses powdered material by scanning cross-sections generated from a 3-D digital description of the part (e.g. from a CAD file or scan data) on the surface of a powder bed.
- After each cross-section is scanned, the powder bed is lowered by one layer thickness, a new layer of material is applied on top, and the process is repeated until the part is completed.
- Compared to other rapid manufacturing methods, SLS can produce parts from a relatively wide range of commercially available powder materials, including polymers (nylon, also glass-filled or with other fillers, and polystyrene), metals (steel, titanium, alloy mixtures and composites) and foundry sand.
- Depending on the material, up to 100% density can be achieved with material properties comparable to those from conventional manufacturing methods.

Source: Wikipedia.org

SLS (3D Systems)



	Sinterstation HiQ	Sinterstation Pro
Workpiece size	381x330x457 mm	550x550x460 mm
Speed	5 m/s	10 m/s
Layer thickness	N/A	0.1, 0.15 mm
Materials	PA, nylon, stainless steel, tool steel	



Source: 3DSystems

Case Study: Skin Stretch Feedback

Power of Solid Freeform Fabrication (e.g., FDM)

- 3D Printing, SLA, FDM are suitable for finished prototypes in many low-force haptic device designs
- Allows rapid iteration of designs and better dimensional control than hand fabrication
- Parts can be integrated/build simultaneously
 - Fewer loose parts
 - Less assembly

Case Study: Power of Solid Freeform Fabrication (e.g., FDM)

- Prior to converting models to FDM-based design, application prototypes were bulky
 - Discrete devices were placed inside of other device housings

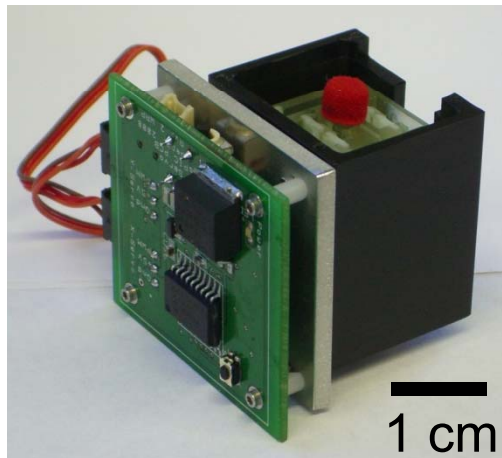

CNC machined skin stretch feedback device

(without thimble above red tactor)

T-Pod Multi-Modal Handheld Device



Case Study: Power of Solid Freeform Fabrication (e.g., FDM)

- Converting models to FDM-based allowed quickly embedding skin stretch feedback into a wide variety of application prototypes

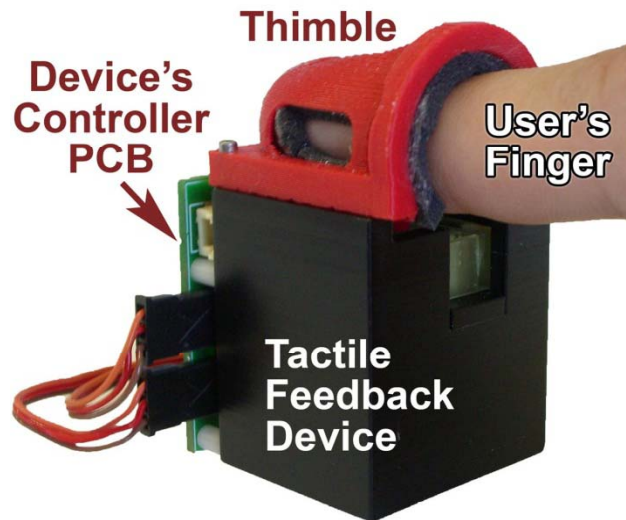

5 hours to CNC machine black delrin device frame assembly

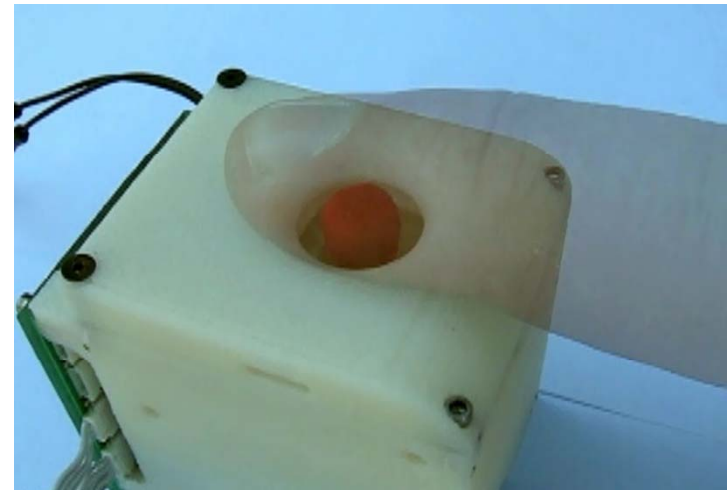
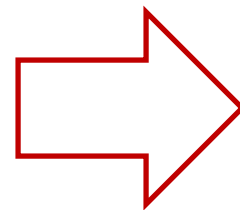

2 hours on FDM machine
Prototypes sub-components simultaneously

Power of Solid Freeform Fabrication (e.g., FDM)

- Converting models to FDM-based allowed quickly embedding into a wide variety of application prototypes



Guidelines/Tips for FDM Designs

- 0.06” (1.5 mm) minimum recommended wall thickness
 - Can have local thin spots as thin as 0.03” (.75 mm) (3 build layers thick)
 - Can use 0.04” (1 mm) wall thickness on parts with low loads
- FDM Parts can be reinforced by painting them with 5-min. epoxy

Guidelines/Tips for FDM Designs

- Use inserts/bushings/bearings to make stronger holes in FDM parts (& threaded holes)
 - Threaded Inserts
 - Press in insert using pin vise, vise, or arbor press



Other FDM Tricks

- Use cloth hinges &/or velcro to make clam-shell assemblies with wide, flexible openings
- Line your FDM parts with foam tape to ease need to have exact fits
 - Also works for fingers, hands, etc.

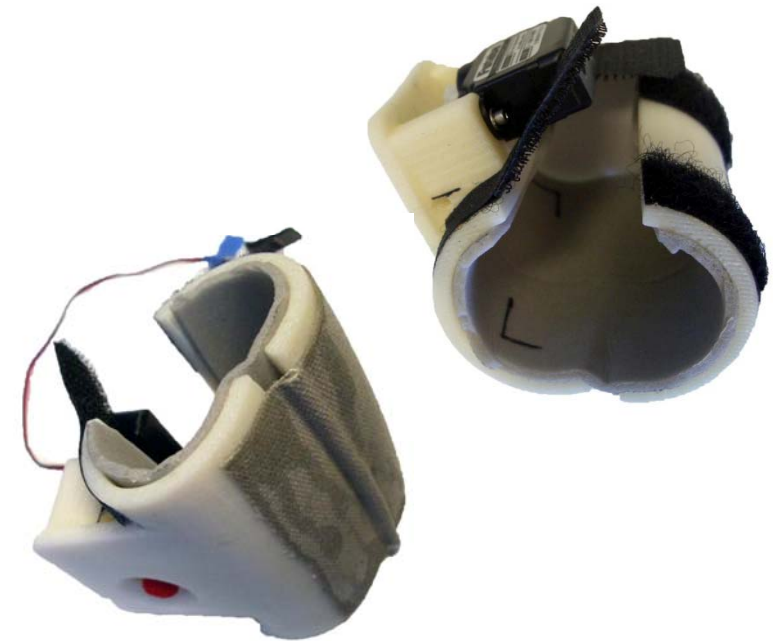

See: Medeiros-Ward, N., Cooper, J. M., Doxon, A. J., Strayer, D. L., and Provancher, W. R., "[Bypassing the Bottleneck: The Advantage of Fingertip Shear Feedback for Navigational Cues](#)," Proc. of the Annual Meeting of the Human Factors and Ergonomics Society, Sept, 2010, pp. 5.

FDM Realities

- You may pay more for “support material” than for your “build material” for some of your parts
- You can use “sparse fill” to reduce the weight of solid parts
- You can use “sparse support” to reduce the cost of support material
- Don’t forget to leave access for solvents to remove support material that is internal to your (hollow) parts
 - Narrow, long holes also sometimes take a long time to dissolve support material

Haptic Device Prototyping Tips

Rotary joints

- Use precision shafts (generally 0.0001-0.0004 inches (2-10 microns) undersized)
- Precision shoulder screws
 - Use shaft spacers to shorten or lengthen effective length of shoulder
 - Use wave washers to absorb extra shaft length & preload bearings



Source: McMaster.com

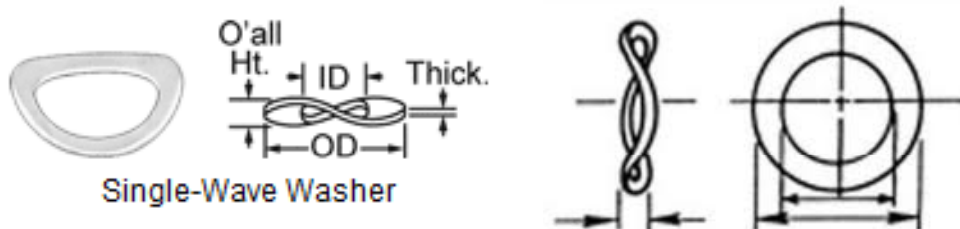

Source: McMaster.com

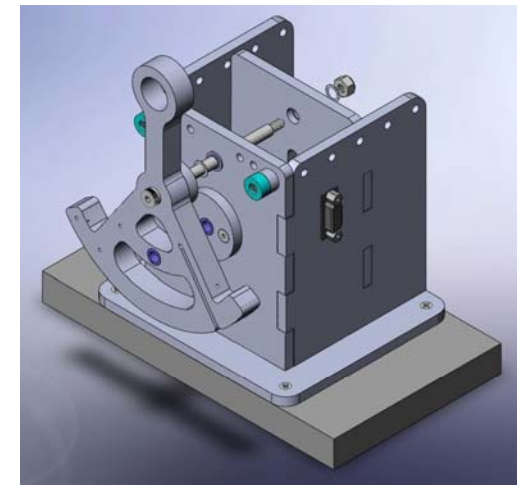

Haptic Device Prototyping Tips

Rotary joints

Another trick if you don't have high axial loads on your shafts...

- Use spring clips (special Retaining Rings) (available from PIC Design (pic-design.com) (e.g., part # Z5-1 for 1/8" diameter shafts used on the Stanford/JHU Haptic Paddle)
- These retaining rings pinch the outer diameter of the shaft and don't require grooves to be machined

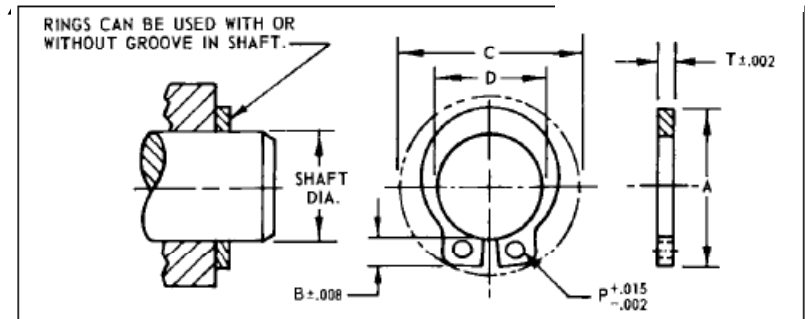
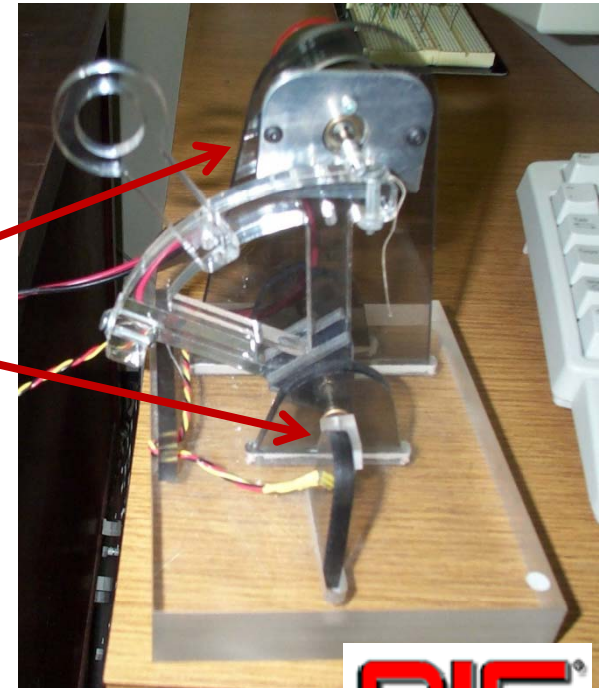

Source: pic-design.com

Haptic Device Prototyping Tips

Bushings/bearings for rotating shafts

- Ball Bearings
 - Smoother and lower friction rotary joints (use ABEC 5 or better)
 - (generally 0.0001-0.0004 inches (2-10 microns) undersized)
 - Use 2 separated bearings for supporting moments/torques
 - Extended inner race/ring is nice to eliminate shaft spacers
- Bronze bushings
 - Less expensive than ball bearings
 - Use for higher loads and lower speeds

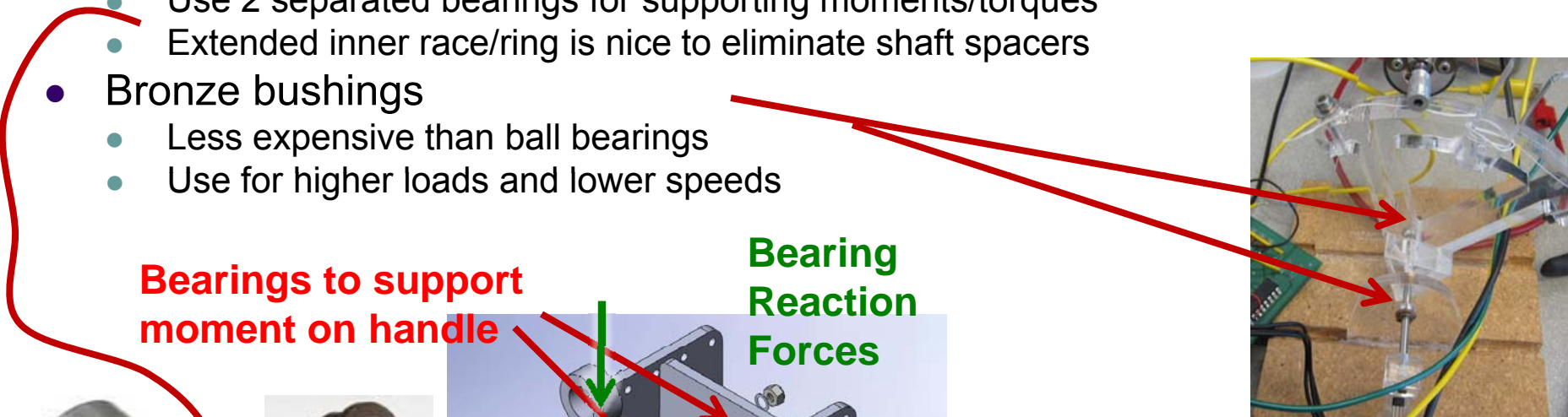

Bearings to support moment on handle

Bearing Reaction Forces



Ball bearing

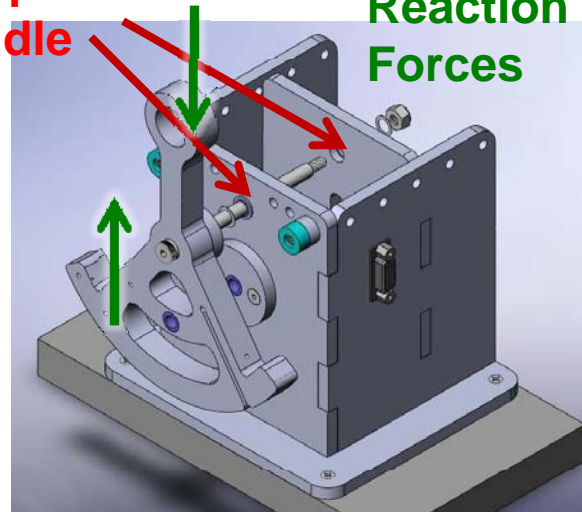

Utah haptic paddle



Bronze bushings

Stanford haptic paddle

Haptic Device Prototyping Tips

Capstan Drives

- Use a threaded rod for a cheap, high friction capstan pulley
 - A center drilled (and reamed to match motor shaft dia.) 3/8-24 (inch) setscrew was used on the Rice haptic paddle (we also used it on the Utah Haptic Paddle)

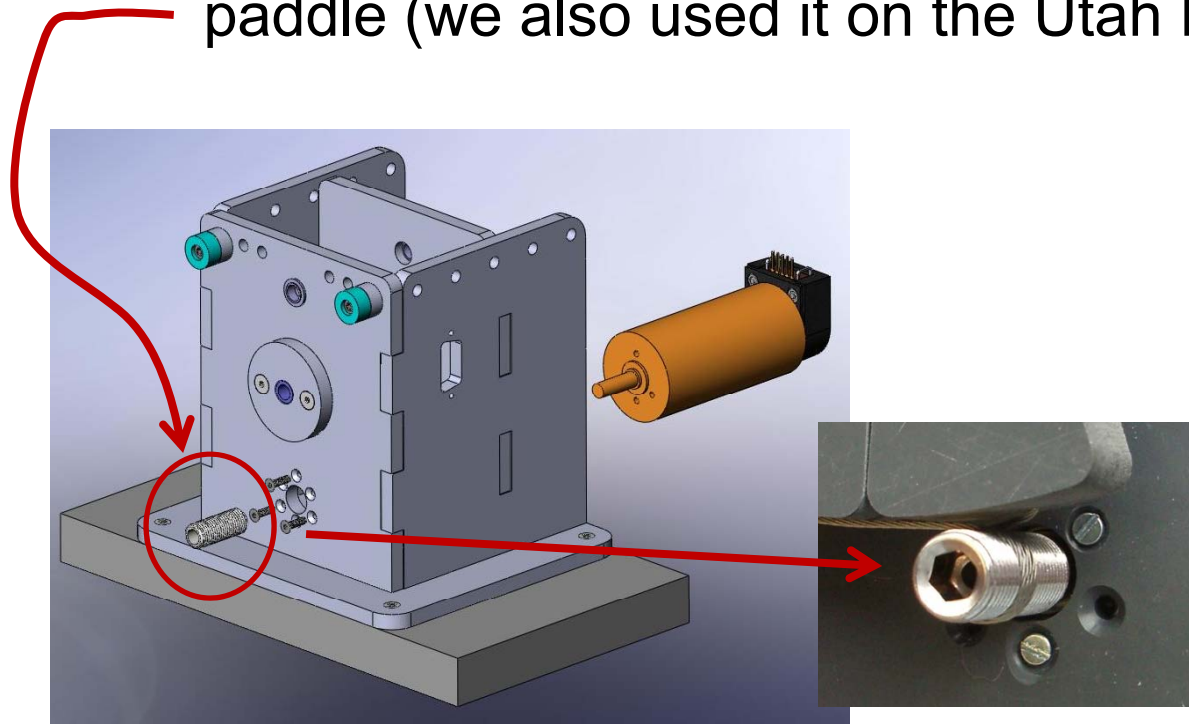

Rice Haptic Paddle
Marcia O'Malley

Questions/Comments???